

# PLC-RSC- 24UC/21 - Relay Module



2966184

<https://www.phoenixcontact.com/gb/products/2966184>

Please be informed that the data shown in this PDF document is generated from our Online Catalog. Please find the complete data in the user documentation. Our General Terms of Use for Downloads are valid.



PLC-INTERFACE, consisting of basic terminal block PLC-BSC.../21 with screw connection and plug-in miniature relay with power contact, for assembly on DIN rail NS 35/7,5, 1 changeover contact, input voltage 24 V AC/DC

## Your advantages

- Slim design
- Efficient connection to system cabling using V8 adapter
- Safe isolation according to DIN EN 50178 between coil and contact
- RT III sealed relay
- Functional plug-in bridges
- Integrated input circuit and interference suppression circuit

## Commercial Data

Item number	2966184
Packing unit	10 pc
Minimum order quantity	10 pc
Sales Key	CK621A
Product Key	CK621A
Catalog Page	Page 364 (C-5-2019)
GTIN	4017918130725
Weight per Piece (including packing)	40.69 g
Weight per Piece (excluding packing)	33.83 g
Customs tariff number	85364190
Country of origin	DE

# PLC-RSC- 24UC/21 - Relay Module

2966184

<https://www.phoenixcontact.com/gb/products/2966184>

## Set consists of

### PLC-BSC- 24UC/21 - Relay base

2966029

<https://www.phoenixcontact.com/gb/products/2966029>



6.2 mm PLC basic terminal block with screw connection, without relay or solid-state relay, for mounting on DIN rail NS 35/7,5, 1 changeover contact, input voltage 24 V AC/DC

---

### REL-MR- 24DC/21 - Single relay

2961105

<https://www.phoenixcontact.com/gb/products/2961105>

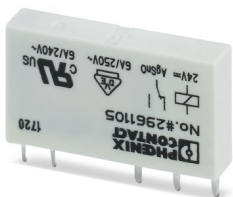

Plug-in miniature power relay, with power contact, 1 changeover contact, input voltage 24 V DC

# PLC-RSC- 24UC/21 - Relay Module



2966184

<https://www.phoenixcontact.com/gb/products/2966184>

## Technical Data

### Notes

General	Separating plate PLC-ATP must be installed for voltages larger than 250 V (L1, L2, L3) between identical terminal blocks in adjacent modules. Potential bridging is then carried out with FBST 8-PLC... or FBST 500....
---------	---

### Product properties

Product type	Relay Module
Product family	PLC-INTERFACE
Application	Universal
Operating mode	100% operating factor
Mechanical service life	2x 10 <sup>7</sup> cycles

### Insulation characteristics

Overvoltage category	III
Pollution degree	3

### Electrical properties

Maximum power dissipation for nominal condition	0.26 W
Test voltage (Winding/contact)	4 kV AC (50 Hz, 1 min., winding/contact)

### Input data

#### Coil side

Nominal input voltage $U_N$	24 V AC/DC
Input voltage range	19.4 V AC/DC ... 33.6 V AC/DC (20 °C)
Typical input current at $U_N$	11 mA (at $U_N = 24$ V AC) 8.5 mA (at $U_N = 24$ V DC)
Typical response time	6 ms
Typical release time	15 ms
Protective circuit	Bridge rectifier; Bridge rectifier
Operating voltage display	Yellow LED

### Output data

#### Switching

Contact type	1 changeover contact
Type of switch contact	Single contact
Drive and function	monostable
Drive (polarity)	polarized
Contact material	AgSnO
Maximum switching voltage	250 V AC/DC (The separating plate PLC-ATP should be installed for voltages larger than 250 V (L1, L2, L3) between identical terminal blocks in adjacent modules. Potential bridging is then carried out with FBST 8-PLC... or ...FBST 500...)

# PLC-RSC- 24UC/21 - Relay Module



2966184

<https://www.phoenixcontact.com/gb/products/2966184>

Minimum switching voltage	5 V (100 mA)
Limiting continuous current	6 A
Maximum inrush current	10 A (4 s)
Min. switching current	10 mA (12 V)
Interrupting rating (ohmic load) max.	140 W (at 24 V DC) 20 W (at 48 V DC) 18 W (at 60 V DC) 23 W (at 110 V DC) 40 W (at 220 V DC) 1500 VA (for 250 V AC)
Switching capacity	2 A (at 24 V, DC13) 0.2 A (at 110 V, DC13) 0.1 A (at 220 V, DC13) 3 A (at 24 V, AC15) 3 A (at 120 V, AC15) 3 A (at 230 V, AC15)

## Connection data

Connection method	Screw connection
Stripping length	8 mm
Screw thread	M3
Conductor cross section rigid	0.14 mm <sup>2</sup> ... 2.5 mm <sup>2</sup>
Conductor cross section flexible	0.14 mm <sup>2</sup> ... 2.5 mm <sup>2</sup> 0.2 mm <sup>2</sup> ... 2.5 mm <sup>2</sup> (Single ferrule) 2x 0.5 mm <sup>2</sup> ... 1.5 mm <sup>2</sup> (TWIN ferrule)
Conductor cross section AWG	26 ... 14
Tightening torque	0.6 Nm ... 0.8 Nm

## Dimensions

Width	6.2 mm
Height	80 mm
Depth	94 mm

## Material specifications

Flammability rating according to UL 94	V0 (Housing)
--	--------------

## Environmental and real-life conditions

### Ambient conditions

Degree of protection (Relay base)	IP20 (Relay base)
Ambient temperature (operation)	-40 °C ... 60 °C
Ambient temperature (storage/transport)	-40 °C ... 85 °C

## Approvals

Corrosive gas test

# PLC-RSC- 24UC/21 - Relay Module



2966184

<https://www.phoenixcontact.com/gb/products/2966184>

Identification	ISA-S71.04. G3 Harsh Group
	EN 60068-2-60

## Standards and regulations

Standards/regulations	IEC 60947-5-1
-----------------------	---------------

## Mounting

Mounting type	DIN rail mounting
Assembly instructions	in rows with zero spacing
Mounting position	any

## Drawings

Diagram

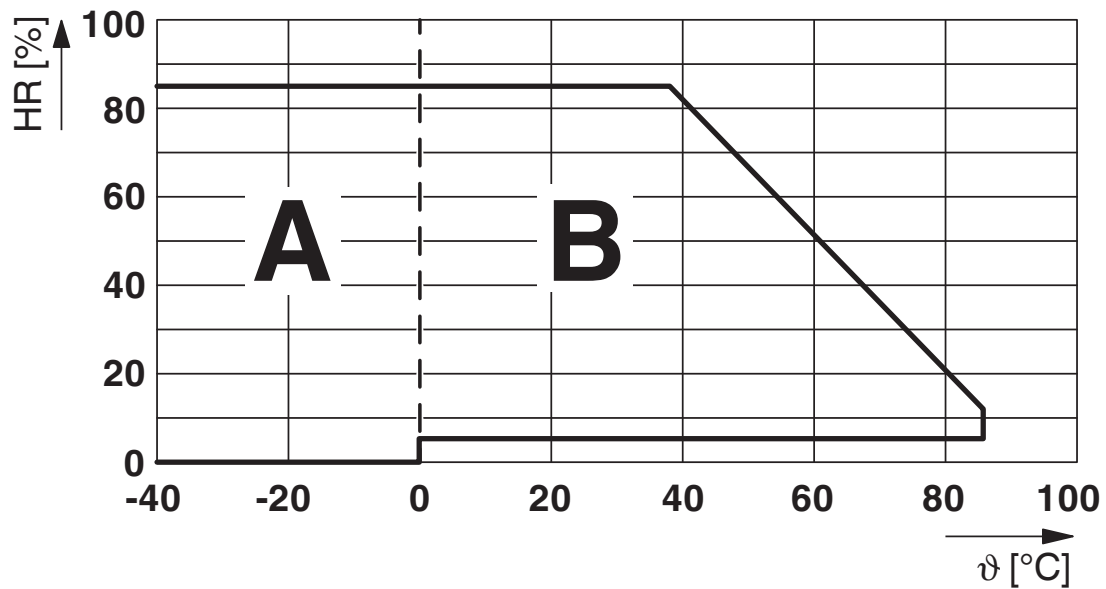

Permissible humidity for operation and storage.

The maximum permissible ambient temperature as specified in the data sheet must be observed.

Area A: Ice buildup at ambient temperatures  $\leq 0^\circ\text{C}$  must be prevented

Area B: Condensation at ambient temperatures  $> 0^\circ\text{C}$  must be prevented

On 30 full days that are naturally distributed across an entire year, a humidity level of 95% is permissible at an ambient temperature  $\leq 25^\circ\text{C}$ .

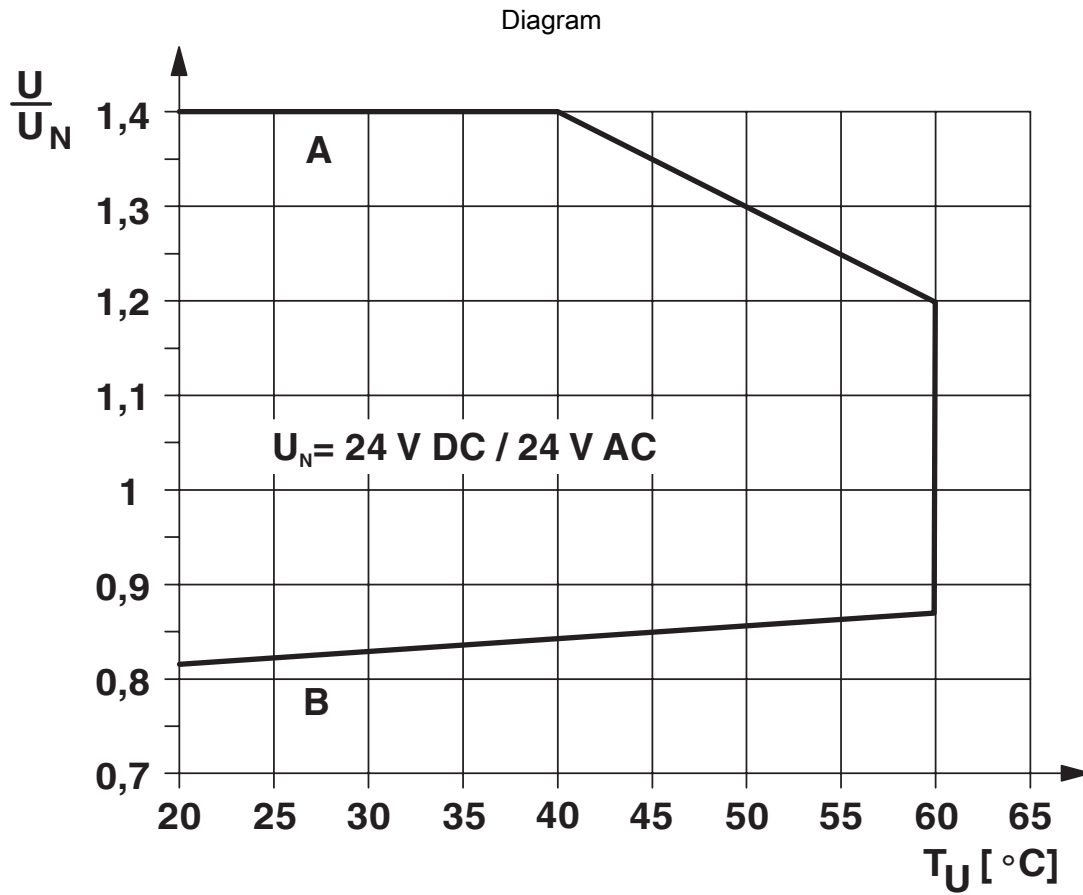

### Curve A

Maximum permissible continuous voltage  $U_{max}$  with limiting continuous current on the contact side (see relevant technical data)

### Curve B

Minimum permissible operate voltage  $U_{op}$  after pre-excitation (see relevant technical data)

# PLC-RSC- 24UC/21 - Relay Module



2966184

<https://www.phoenixcontact.com/gb/products/2966184>

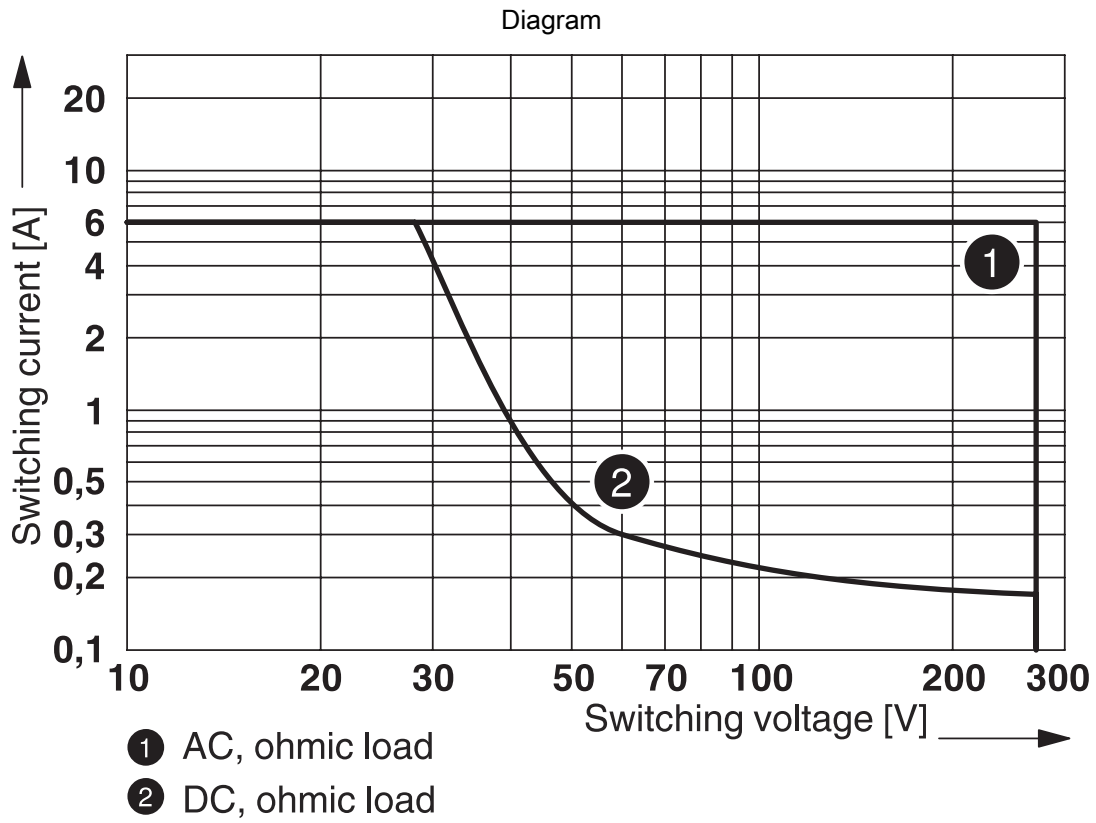

Interrupting rating



Diagram

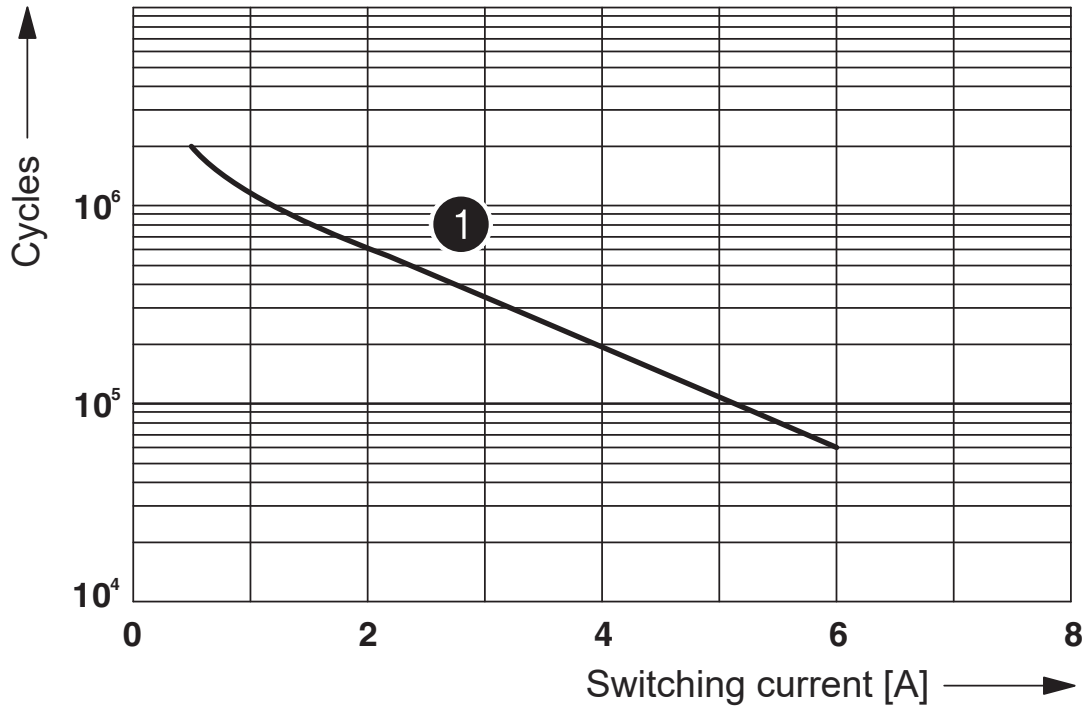

① 250 V AC, ohmic load

Electrical service life

Circuit diagram

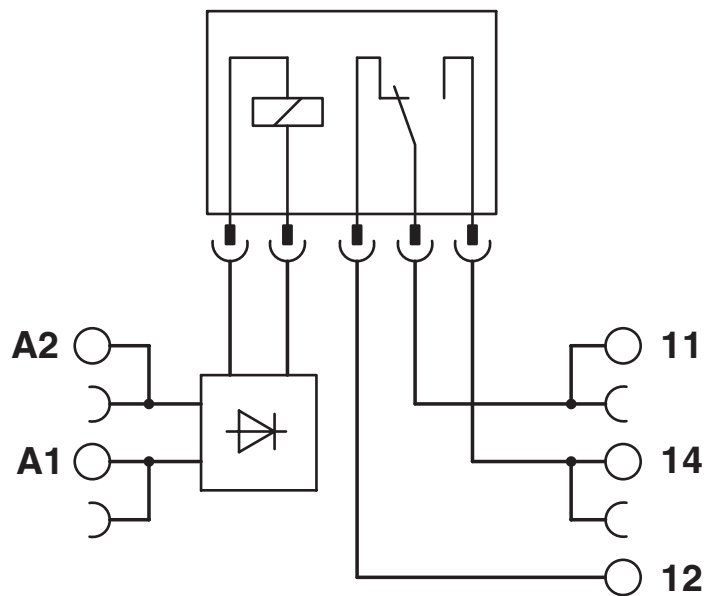

# PLC-RSC- 24UC/21 - Relay Module



2966184

<https://www.phoenixcontact.com/gb/products/2966184>

## Approvals

To download certificates, visit the product detail page: <https://www.phoenixcontact.com/gb/products/2966184>



**cUL Recognized**  
Approval ID: FILE E 238705



**UL Recognized**  
Approval ID: FILE E 238705



**EAC**  
Approval ID: TR\_TS\_D\_00573\_c



**DNV GL**  
Approval ID: TAE0000196



**EAC**  
Approval ID: RU\*C-DE.\*08.B.00010



**UL Listed**  
Approval ID: FILE E 172140



**cUL Listed**  
Approval ID: FILE E 172140

# PLC-RSC- 24UC/21 - Relay Module



2966184

<https://www.phoenixcontact.com/gb/products/2966184>

## Classifications

### ECLASS

ECLASS-11.0	27371601
ECLASS-12.0	27371601
ECLASS-13.0	27371601

### ETIM

ETIM 8.0	EC001437
----------	----------

### UNSPSC

UNSPSC 21.0	39122300
-------------	----------

# PLC-RSC- 24UC/21 - Relay Module



2966184

<https://www.phoenixcontact.com/gb/products/2966184>

## Environmental Product Compliance

REACH SVHC	Lead 7439-92-1
	Hexahydromethylphthalic anhydride
China RoHS	Environmentally Friendly Use Period = 50 years
	For information on hazardous substances, refer to the manufacturer's declaration available under "Downloads"

# PLC-RSC- 24UC/21 - Relay Module

2966184

<https://www.phoenixcontact.com/gb/products/2966184>

## Accessories

 Note: Applying some accessories below might limit this product.

### FBST 500-PLC RD - Continuous plug-in bridge

2966786

<https://www.phoenixcontact.com/gb/products/2966786>



Continuous plug-in bridge, length: 500 mm, color: red

 Max. current carrying capacity: 32 A

---

### FBST 500-PLC BU - Continuous plug-in bridge

2966692

<https://www.phoenixcontact.com/gb/products/2966692>

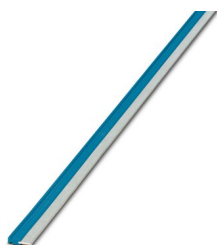

Continuous plug-in bridge, length: 500 mm, color: blue

 Max. current carrying capacity: 32 A

# PLC-RSC- 24UC/21 - Relay Module

2966184

<https://www.phoenixcontact.com/gb/products/2966184>



## FBST 500-PLC GY - Continuous plug-in bridge

2966838

<https://www.phoenixcontact.com/gb/products/2966838>



Continuous plug-in bridge, length: 500 mm, color: gray

 Max. current carrying capacity: 32 A

---

## FBST 6-PLC RD - Single plug-in bridge

2966236

<https://www.phoenixcontact.com/gb/products/2966236>

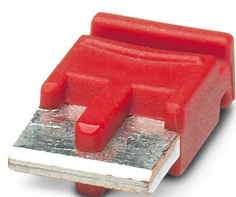

Single plug-in bridge, number of positions: 2, length: 6 mm, color: red

 Max. current carrying capacity: 6 A

# PLC-RSC- 24UC/21 - Relay Module

2966184

<https://www.phoenixcontact.com/gb/products/2966184>



## FBST 6-PLC BU - Single plug-in bridge

2966812

<https://www.phoenixcontact.com/gb/products/2966812>

Single plug-in bridge, number of positions: 2, length: 6 mm, color: blue



 Max. current carrying capacity: 6 A

---

## FBST 6-PLC GY - Single plug-in bridge

2966825

<https://www.phoenixcontact.com/gb/products/2966825>

Single plug-in bridge, number of positions: 2, length: 6 mm, color: gray

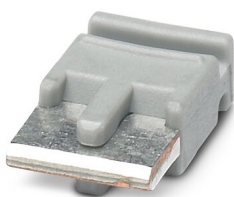

 Max. current carrying capacity: 6 A

# PLC-RSC- 24UC/21 - Relay Module

2966184

<https://www.phoenixcontact.com/gb/products/2966184>



## FBST 8-PLC GY - Single plug-in bridge

2967688

<https://www.phoenixcontact.com/gb/products/2967688>

Single plug-in bridge, number of positions: 2, length: 8 mm, color: gray



 Max. current carrying capacity: 6 A

---

## PLC-ESK GY - Power terminal block

2966508

<https://www.phoenixcontact.com/gb/products/2966508>

Power terminal block, for the input of up to four potentials, for mounting on NS 35/7.5





# PLC-RSC- 24UC/21 - Relay Module

2966184

<https://www.phoenixcontact.com/gb/products/2966184>



## PLC-ATP BK - Separating plate

2966841

<https://www.phoenixcontact.com/gb/products/2966841>



Separating plate, 2 mm thick, required at the start and end of a PLC terminal strip. Furthermore, it is used for: visual separation of groups, safe isolation of different voltages of neighboring PLC relays in acc. with DIN VDE 0106-101, isolation

---

## SZF 1-0,6X3,5 - Screwdriver

1204517

<https://www.phoenixcontact.com/gb/products/1204517>



Actuation tool, for ST terminal blocks, also suitable for use as a bladed screwdriver, size: 0.6 x 3.5 x 100 mm, 2-component grip, with non-slip grip

# PLC-RSC- 24UC/21 - Relay Module

2966184

<https://www.phoenixcontact.com/gb/products/2966184>



## PLC-FA-5X20 - Fuse adapter

1186510

<https://www.phoenixcontact.com/gb/products/1186510>



Safety plug adapter for use on a 6.2 mm PLC basic terminal block. For 5 x 20 mm fuses. Operating voltage: Universal. Without fuse failure indication.

---

## PLC-FA-I-5X20-12-24UC - Fuse adapter

1186499

<https://www.phoenixcontact.com/gb/products/1186499>



Safety plug adapter for use on a 6.2 mm PLC basic terminal block. For 5 x 20 mm fuses. Operating voltage: 12 ... 24 V AC/DC. With LED for fuse failure indication.

# PLC-RSC- 24UC/21 - Relay Module

2966184

<https://www.phoenixcontact.com/gb/products/2966184>



## PLC-FA-I-5X20-120-230UC - Fuse adapter

1186508

<https://www.phoenixcontact.com/gb/products/1186508>



Safety plug adapter for use on a 6.2 mm PLC basic terminal block. For 5 x 20 mm fuses. Operating voltage: 120 ... 230 V AC/DC. With LED for fuse failure indication.

---

## ZB 6:UNBEDRUCKT - Zack marker strip

1051003

<https://www.phoenixcontact.com/gb/products/1051003>



Zack marker strip, Strip, white, unlabeled, can be labeled with: PLOTMARK, CMS-P1-PLOTTER, mounting type: snapped, for terminal block width: 6.2 mm, lettering field size: 6.15 x 10.5 mm, Number of individual labels: 10

# PLC-RSC- 24UC/21 - Relay Module

2966184

<https://www.phoenixcontact.com/gb/products/2966184>



## ZB 6 CUS - Zack marker strip

0824992

<https://www.phoenixcontact.com/gb/products/0824992>



Zack marker strip, can be ordered: Strip, white, labeled according to customer specifications, mounting type: snap into tall marker groove, for terminal block width: 6.2 mm, lettering field size: 6.15 x 10.5 mm, Number of individual labels: 10

---

## ZB 6,LGS:FORTL.ZAHLEN - Zack marker strip

1051016

<https://www.phoenixcontact.com/gb/products/1051016>



Zack marker strip, Strip, white, labeled, can be labeled with: CMS-P1-PLOTTER, printed horizontally: consecutive numbers 1 ... 10, 11 ... 20, etc. up to 491 ... 500, mounting type: snapped, for terminal block width: 6.2 mm, lettering field size: 6.15 x 10.5 mm, Number of individual labels: 10

# PLC-RSC- 24UC/21 - Relay Module

2966184

<https://www.phoenixcontact.com/gb/products/2966184>

## ZB 6,QR:FORTL.ZAHLEN - Zack marker strip

1051029

<https://www.phoenixcontact.com/gb/products/1051029>

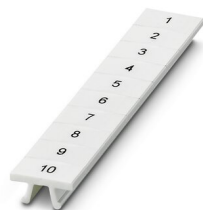

Zack marker strip, Strip, white, labeled, can be labeled with: CMS-P1-PLOTTER, Printed vertically: consecutive numbers 1 ... 10, 11 ... 20, etc. up to 491 ... 500, mounting type: snapped, for terminal block width: 6.2 mm, lettering field size: 6.15 x 10.5 mm, Number of individual labels: 10

---

## ZB 6,LGS:GLEICHE ZAHLEN - Zack marker strip

1051032

<https://www.phoenixcontact.com/gb/products/1051032>



Zack marker strip, Strip, white, labeled, can be labeled with: CMS-P1-PLOTTER, printed horizontally: Identical numbers 1 or 2, etc. up to 100, mounting type: snapped, for terminal block width: 6.2 mm, lettering field size: 6.15 x 10.5 mm, Number of individual labels: 10

# PLC-RSC- 24UC/21 - Relay Module

2966184

<https://www.phoenixcontact.com/gb/products/2966184>

## ZB 6,LGS:L1-N,PE - Marker for terminal blocks

1051414

<https://www.phoenixcontact.com/gb/products/1051414>



Marker for terminal blocks, Strip, white, labeled, can be labeled with: CMS-P1-PLOTTER, horizontal: L1, L2, L3, N, PE, L1, L2, L3, N, PE, mounting type: snapped, for terminal block width: 6.2 mm, lettering field size: 6.15 x 10.5 mm, Number of individual labels: 10

---

## ZB 6,LGS:U-N - Marker for terminal blocks

1051430

<https://www.phoenixcontact.com/gb/products/1051430>



Marker for terminal blocks, Strip, white, labeled, can be labeled with: CMS-P1-PLOTTER, printed horizontally: U, V, W, N, GND, U, V, W, N, GND, mounting type: snapped, for terminal block width: 6.2 mm, lettering field size: 6.15 x 10.5 mm, Number of individual labels: 10

# PLC-RSC- 24UC/21 - Relay Module



2966184

<https://www.phoenixcontact.com/gb/products/2966184>

## UC-TM 6 - Marker for terminal blocks

0818085

<https://www.phoenixcontact.com/gb/products/0818085>



Marker for terminal blocks, Sheet, white, unlabeled, can be labeled with: BLUEMARK ID COLOR, BLUEMARK ID, BLUEMARK CLED, PLOTMARK, CMS-P1-PLOTTER, mounting type: snapped, for terminal block width: 6.2 mm, lettering field size: 5.6 x 10.5 mm, Number of individual labels: 80

---

## UC-TM 6 CUS - Marker for terminal blocks

0824589

<https://www.phoenixcontact.com/gb/products/0824589>



Marker for terminal blocks, can be ordered: by sheet, white, labeled according to customer specifications, mounting type: snap into tall marker groove, for terminal block width: 6.2 mm, lettering field size: 5.6 x 10.5 mm, Number of individual labels: 80

# PLC-RSC- 24UC/21 - Relay Module

2966184

<https://www.phoenixcontact.com/gb/products/2966184>



## UCT-TM 6 - Marker for terminal blocks

0828736

<https://www.phoenixcontact.com/gb/products/0828736>



Marker for terminal blocks, Sheet, white, unlabeled, can be labeled with: TOPMARK NEO, TOPMARK LASER, BLUEMARK ID COLOR, BLUEMARK ID, BLUEMARK CLED, THERMOMARK PRIME, THERMOMARK CARD 2.0, THERMOMARK CARD, mounting type: snapped, for terminal block width: 6.2 mm, lettering field size: 5.6 x 10.5 mm, Number of individual labels: 60

---

## UCT-TM 6 CUS - Marker for terminal blocks

0829602

<https://www.phoenixcontact.com/gb/products/0829602>



Marker for terminal blocks, can be ordered: by sheet, white, labeled according to customer specifications, mounting type: snap into tall marker groove, for terminal block width: 6.2 mm, lettering field size: 5.6 x 10.5 mm, Number of individual labels: 60



# PLC-RSC- 24UC/21 - Relay Module

2966184

<https://www.phoenixcontact.com/gb/products/2966184>



## NS 35/ 7,5 PERF 2000MM - DIN rail perforated

0801733

<https://www.phoenixcontact.com/gb/products/0801733>



DIN rail perforated, acc. to EN 60715, material: Steel, galvanized, passivated with a thick layer, Standard profile, color: silver, Pack of 25 (50 m)

---

## NS 35/ 7,5 UNPERF 2000MM - DIN rail, unperforated

0801681

<https://www.phoenixcontact.com/gb/products/0801681>



DIN rail, unperforated, acc. to EN 60715, material: Steel, galvanized, passivated with a thick layer, Standard profile, color: silver, Pack of 25 (50 m)

# PLC-RSC- 24UC/21 - Relay Module

2966184

<https://www.phoenixcontact.com/gb/products/2966184>



## NS 35/ 7,5 WH PERF 2000MM - DIN rail perforated

1204119

<https://www.phoenixcontact.com/gb/products/1204119>



DIN rail perforated, acc. to EN 60715, material: Steel, Galvanized, white passivated, Standard profile, color: silver, Pack of 25 (50 m)

---

## NS 35/ 7,5 WH UNPERF 2000MM-VPE 10 - DIN rail, unperforated

1204122

<https://www.phoenixcontact.com/gb/products/1204122>



DIN rail, unperforated, acc. to EN 60715, material: Steel, Galvanized, white passivated, Standard profile, color: silver, Pack of 10 (20 m)

# PLC-RSC- 24UC/21 - Relay Module

2966184

<https://www.phoenixcontact.com/gb/products/2966184>



## NS 35/ 7,5 AL UNPERF 2000MM - DIN rail, unperforated

0801704

<https://www.phoenixcontact.com/gb/products/0801704>



DIN rail, unperforated, acc. to EN 60715, material: Aluminum, uncoated, Standard profile, color: silver, Pack of 25 (50 m)

---

## NS 35/ 7,5 ZN PERF 2000MM - DIN rail perforated

1206421

<https://www.phoenixcontact.com/gb/products/1206421>



DIN rail perforated, acc. to EN 60715, material: Steel, galvanized, Standard profile, color: silver, Pack of 25 (50 m)

# PLC-RSC- 24UC/21 - Relay Module

2966184

<https://www.phoenixcontact.com/gb/products/2966184>



## NS 35/ 7,5 ZN UNPERF 2000MM - DIN rail, unperforated

1206434

<https://www.phoenixcontact.com/gb/products/1206434>



DIN rail, unperforated, acc. to EN 60715, material: Steel, galvanized, Standard profile, color: silver, Pack of 25 (50 m)

---

## NS 35/ 7,5 CU UNPERF 2000MM-VPE 10 - DIN rail, unperforated

0801762

<https://www.phoenixcontact.com/gb/products/0801762>



DIN rail, unperforated, acc. to EN 60715, material: Copper, uncoated, Standard profile, color: copper-colored, Pack of 10 (20 m)

# PLC-RSC- 24UC/21 - Relay Module

2966184

<https://www.phoenixcontact.com/gb/products/2966184>



## NS 35/ 7,5 CAP - End cap

1206560

<https://www.phoenixcontact.com/gb/products/1206560>

DIN rail end piece, for DIN rail NS 35/7.5



---

## NS 35/15 PERF 2000MM - DIN rail perforated

1201730

<https://www.phoenixcontact.com/gb/products/1201730>



DIN rail perforated, similar to EN 60715, material: Steel, galvanized, passivated with a thick layer, Standard profile, color: silver, Pack of 25 (50 m)

# PLC-RSC- 24UC/21 - Relay Module

2966184

<https://www.phoenixcontact.com/gb/products/2966184>



## NS 35/15 UNPERF 2000MM - DIN rail, unperforated

1201714

<https://www.phoenixcontact.com/gb/products/1201714>



DIN rail, unperforated, similar to EN 60715, material: Steel, galvanized, passivated with a thick layer, Standard profile, color: silver, Pack of 25 (50 m)

---

## NS 35/15 WH PERF 2000MM - DIN rail perforated

0806602

<https://www.phoenixcontact.com/gb/products/0806602>



DIN rail perforated, similar to EN 60715, material: Steel, Galvanized, white passivated, Standard profile, color: white, Pack of 25 (50 m)

# PLC-RSC- 24UC/21 - Relay Module

2966184

<https://www.phoenixcontact.com/gb/products/2966184>



## NS 35/15 WH UNPERF 2000MM-VPE 10 - DIN rail, unperforated

1204135

<https://www.phoenixcontact.com/gb/products/1204135>



DIN rail, unperforated, similar to EN 60715, material: Steel, Galvanized, white passivated, Standard profile, color: silver, Pack of 10 (20 m)

---

## NS 35/15 AL UNPERF 2000MM - DIN rail, unperforated

1201756

<https://www.phoenixcontact.com/gb/products/1201756>



DIN rail, unperforated, similar to EN 60715, material: Aluminum, uncoated, Standard profile, color: silver

# PLC-RSC- 24UC/21 - Relay Module

2966184

<https://www.phoenixcontact.com/gb/products/2966184>



## NS 35/15 ZN PERF 2000MM - DIN rail perforated

1206599

<https://www.phoenixcontact.com/gb/products/1206599>



DIN rail perforated, similar to EN 60715, material: Steel, galvanized, Standard profile, color: silver, Pack of 25 (50 m)

---

## NS 35/15 ZN UNPERF 2000MM - DIN rail, unperforated

1206586

<https://www.phoenixcontact.com/gb/products/1206586>



DIN rail, unperforated, similar to EN 60715, material: Steel, galvanized, Standard profile, color: silver, Pack of 25 (50 m)



# PLC-RSC- 24UC/21 - Relay Module

2966184

<https://www.phoenixcontact.com/gb/products/2966184>



## NS 35/15 CU UNPERF 2000MM-VPE 10 - DIN rail, unperforated

1201895

<https://www.phoenixcontact.com/gb/products/1201895>



DIN rail, unperforated, similar to EN 60715, material: Copper, uncoated, Standard profile, color: copper-colored, Pack of 10 (20 m)

---

## NS 35/15 CAP - End cap

1206573

<https://www.phoenixcontact.com/gb/products/1206573>

DIN rail end piece, for DIN rail NS 35/15



# PLC-RSC- 24UC/21 - Relay Module

2966184

<https://www.phoenixcontact.com/gb/products/2966184>



## NS 35/15-2,3 UNPERF 2000MM-VPE 10 - DIN rail, unperforated

1201798

<https://www.phoenixcontact.com/gb/products/1201798>



DIN rail, unperforated, acc. to EN 60715, material: Steel, galvanized, passivated with a thick layer, Standard profile 2.3 mm, color: silver, Pack of 10 (20 m)

---

## PLC-BSC- 24UC/21 - Relay base

2966029

<https://www.phoenixcontact.com/gb/products/2966029>



6.2 mm PLC basic terminal block with screw connection, without relay or solid-state relay, for mounting on DIN rail NS 35/7,5, 1 changeover contact, input voltage 24 V AC/DC

# PLC-RSC- 24UC/21 - Relay Module

2966184

<https://www.phoenixcontact.com/gb/products/2966184>



## REL-MR- 24DC/21 - Single relay

2961105

<https://www.phoenixcontact.com/gb/products/2961105>

Plug-in miniature power relay, with power contact, 1 changeover contact, input voltage 24 V DC

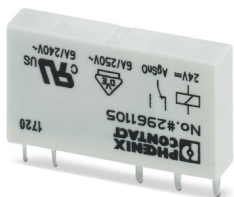

---

Phoenix Contact 2023 © - all rights reserved

<https://www.phoenixcontact.com>

PHOENIX CONTACT Ltd

Halesfield 13, Telford

Shropshire, TF7 4PG

01952 681700

[info@phoenixcontact.co.uk](mailto:info@phoenixcontact.co.uk)