

# PLC-OSC- 24DC/ 24DC/ 2 - Solid-state relay module



2966634

<https://www.phoenixcontact.com/gb/products/2966634>

Please be informed that the data shown in this PDF document is generated from our Online Catalog. Please find the complete data in the user documentation. Our General Terms of Use for Downloads are valid.



PLC-INTERFACE, consisting of PLC-BSC.../21 basic terminal block with screw connection and plug-in miniature solid-state relay, for mounting on DIN rail NS 35/7,5, 1 N/O contact, input: 24 V DC, output: 3 - 33 V DC/3 A

## Your advantages

- Slim design
- Efficient connection to system cabling using V8 adapter
- RT III sealed solid-state relay
- Integrated input circuit
- Functional plug-in bridges
- Zero voltage switch at AC output
- High switching power

## Commercial Data

Item number	2966634
Packing unit	10 pc
Minimum order quantity	10 pc
Sales Key	CK6213
Product Key	CK6213
Catalog Page	Page 373 (C-5-2019)
GTIN	4017918130480
Weight per Piece (including packing)	38.4 g
Weight per Piece (excluding packing)	35.5 g
Customs tariff number	85364190
Country of origin	DE

## Technical Data

### Product properties

Product type	Solid-state relay module
Product family	PLC-INTERFACE
Application	Universal
Operating mode	100% operating factor

### Insulation characteristics

Insulation	Basic insulation
------------	------------------

### Insulation characteristics: Standards/regulations

Insulation	Basic insulation
Overvoltage category	III
Pollution degree	2

### Electrical properties

Maximum power dissipation for nominal condition	0.2 W
Test voltage (Input/output)	2.5 kV (50 Hz, 1 min., input/output)

### Input data

Nominal input voltage $U_N$	24 V DC
Input voltage range in reference to $U_N$	0.8 ... 1.2
Input voltage range	19.2 V DC ... 28.8 V DC
Switching threshold "0" signal in reference to $U_N$	$\leq 0.4$
Switching threshold "1" signal in reference to $U_N$	$\geq 0.8$
Typical input current at $U_N$	8.5 mA
Typical response time	20 $\mu$ s (at $U_N$ )
Typical turn-off time	300 $\mu$ s (at $U_N$ )
Operating voltage display	Yellow LED
Protective circuit	Reverse polarity protection; Polarity protection diode Freewheeling diode; Freewheeling diode
Transmission frequency	300 Hz

### Output data

Contact type	1 N/O contact
Design of digital output	electronic
Type of contact	Power contact
Output voltage range	3 V DC ... 33 V DC
Limiting continuous current	3 A (see derating curve)
Maximum inrush current	15 A (10 ms)
Voltage drop at max. limiting continuous current	$\leq 200$ mV
Output circuit	2-conductor, floating
Protective circuit	Reverse polarity protection; Polarity protection diode

# PLC-OSC- 24DC/ 24DC/ 2 - Solid-state relay module



2966634

<https://www.phoenixcontact.com/gb/products/2966634>

	Surge protection
--	------------------

## Connection data

Connection method	Screw connection
Stripping length	8 mm
Screw thread	M3
Conductor cross section rigid	0.14 mm <sup>2</sup> ... 2.5 mm <sup>2</sup>
Conductor cross section flexible	0.14 mm <sup>2</sup> ... 2.5 mm <sup>2</sup>
	0.2 mm <sup>2</sup> ... 2.5 mm <sup>2</sup> (Single ferrule)
	2x 0.5 mm <sup>2</sup> ... 1.5 mm <sup>2</sup> (TWIN ferrule)
Conductor cross section AWG	26 ... 14
Tightening torque	0.6 Nm ... 0.8 Nm

## Dimensions

Width	6.2 mm
Height	80 mm
Depth	94 mm

## Material specifications

Flammability rating according to UL 94	V0 (Housing)
--	--------------

## Environmental and real-life conditions

### Ambient conditions

Ambient temperature (operation)	-25 °C ... 60 °C
Ambient temperature (storage/transport)	-25 °C ... 70 °C

## Approvals

### Corrosive gas test

Identification	ISA-S71.04. G3 Harsh Group
	EN 60068-2-60

## Standards and regulations

### Standards/regulations

Standards/regulations	IEC 60947-5-1
-----------------------	---------------

## Mounting

Mounting type	DIN rail mounting
Assembly instructions	in rows with zero spacing
Mounting position	any

# PLC-OSC- 24DC/ 24DC/ 2 - Solid-state relay module



2966634

<https://www.phoenixcontact.com/gb/products/2966634>

## Drawings

Diagram

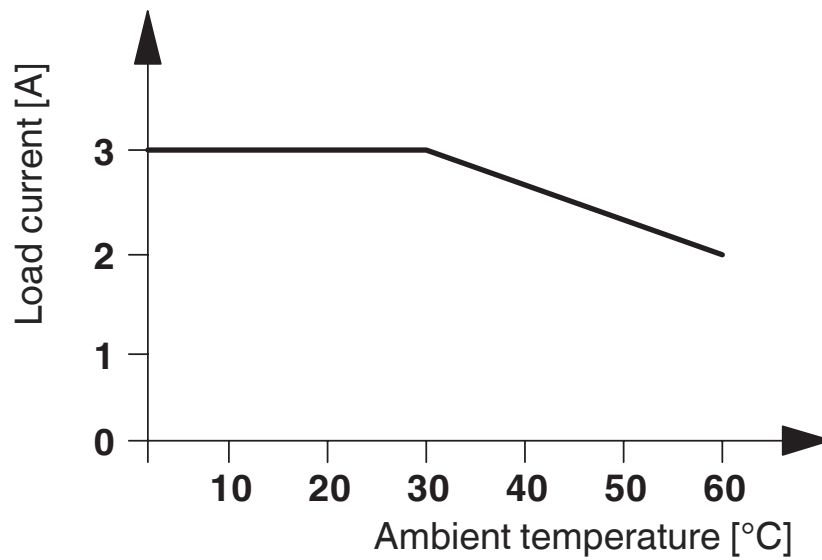

Circuit diagram

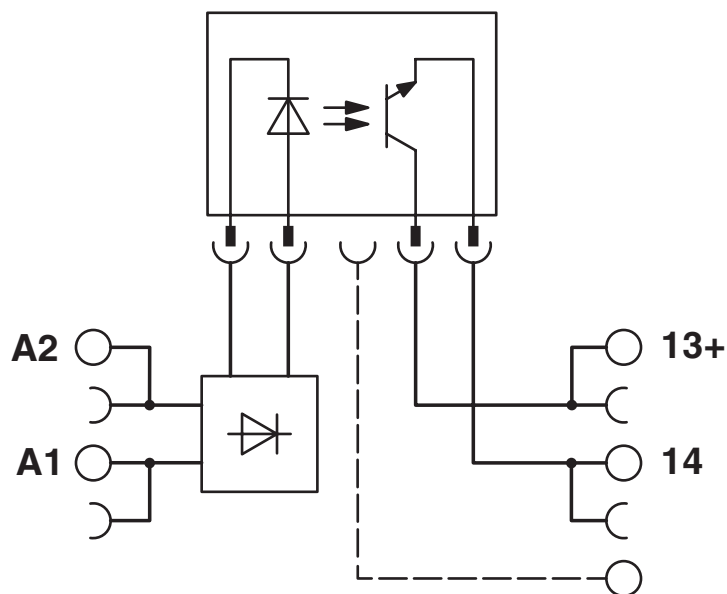

2966634

<https://www.phoenixcontact.com/gb/products/2966634>

## Approvals

To download certificates, visit the product detail page: <https://www.phoenixcontact.com/gb/products/2966634>



**cUL Recognized**  
Approval ID: FILE E 238705



**UL Recognized**  
Approval ID: FILE E 238705



**EAC**  
Approval ID: TR\_TS\_D\_00573\_c



**DNV GL**  
Approval ID: TAE0000196



**UL Listed**  
Approval ID: FILE E 172140



**cUL Listed**  
Approval ID: FILE E 172140

# PLC-OSC- 24DC/ 24DC/ 2 - Solid-state relay module



2966634

<https://www.phoenixcontact.com/gb/products/2966634>

## Classifications

### ECLASS

ECLASS-11.0	27371604
ECLASS-12.0	27371604
ECLASS-13.0	27371604

### ETIM

ETIM 8.0	EC001504
----------	----------

### UNSPSC

UNSPSC 21.0	39122300
-------------	----------

# PLC-OSC- 24DC/ 24DC/ 2 - Solid-state relay module



2966634

<https://www.phoenixcontact.com/gb/products/2966634>

## Environmental Product Compliance

REACH SVHC	Lead 7439-92-1
	Hexahydromethylphthalic anhydride
China RoHS	Environmentally Friendly Use Period = 50 years
	For information on hazardous substances, refer to the manufacturer's declaration available under "Downloads"

# PLC-OSC- 24DC/ 24DC/ 2 - Solid-state relay module



2966634

<https://www.phoenixcontact.com/gb/products/2966634>

## Accessories

**i** Note: Applying some accessories below might limit this product.

### FBST 500-PLC RD - Continuous plug-in bridge

2966786

<https://www.phoenixcontact.com/gb/products/2966786>



Continuous plug-in bridge, length: 500 mm, color: red

**i** Max. current carrying capacity: 32 A

---

### FBST 500-PLC BU - Continuous plug-in bridge

2966692

<https://www.phoenixcontact.com/gb/products/2966692>

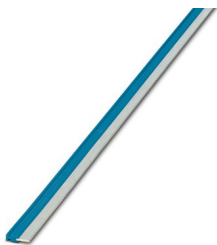

Continuous plug-in bridge, length: 500 mm, color: blue

**i** Max. current carrying capacity: 32 A



# PLC-OSC- 24DC/ 24DC/ 2 - Solid-state relay module

2966634

<https://www.phoenixcontact.com/gb/products/2966634>

## FBST 500-PLC GY - Continuous plug-in bridge

2966838

<https://www.phoenixcontact.com/gb/products/2966838>



Continuous plug-in bridge, length: 500 mm, color: gray

 Max. current carrying capacity: 32 A

---

## FBST 6-PLC RD - Single plug-in bridge

2966236

<https://www.phoenixcontact.com/gb/products/2966236>

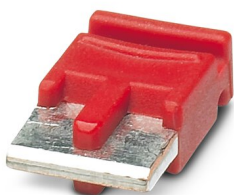

Single plug-in bridge, number of positions: 2, length: 6 mm, color: red

 Max. current carrying capacity: 6 A

# PLC-OSC- 24DC/ 24DC/ 2 - Solid-state relay module



2966634

<https://www.phoenixcontact.com/gb/products/2966634>

## FBST 6-PLC BU - Single plug-in bridge

2966812

<https://www.phoenixcontact.com/gb/products/2966812>

Single plug-in bridge, number of positions: 2, length: 6 mm, color: blue



 Max. current carrying capacity: 6 A

---

## FBST 6-PLC GY - Single plug-in bridge

2966825

<https://www.phoenixcontact.com/gb/products/2966825>

Single plug-in bridge, number of positions: 2, length: 6 mm, color: gray

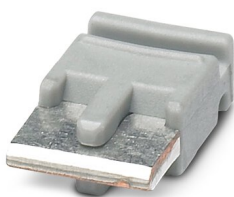

 Max. current carrying capacity: 6 A

# PLC-OSC- 24DC/ 24DC/ 2 - Solid-state relay module



2966634

<https://www.phoenixcontact.com/gb/products/2966634>

## FBST 8-PLC GY - Single plug-in bridge

2967688

<https://www.phoenixcontact.com/gb/products/2967688>

Single plug-in bridge, number of positions: 2, length: 8 mm, color: gray



 Max. current carrying capacity: 6 A

---

## PLC-ESK GY - Power terminal block

2966508

<https://www.phoenixcontact.com/gb/products/2966508>

Power terminal block, for the input of up to four potentials, for mounting on NS 35/7.5



# PLC-OSC- 24DC/ 24DC/ 2 - Solid-state relay module



2966634

<https://www.phoenixcontact.com/gb/products/2966634>

## PLC-ATP BK - Separating plate

2966841

<https://www.phoenixcontact.com/gb/products/2966841>



Separating plate, 2 mm thick, required at the start and end of a PLC terminal strip. Furthermore, it is used for: visual separation of groups, safe isolation of different voltages of neighboring PLC relays in acc. with DIN VDE 0106-101, isolation

---

## SZF 1-0,6X3,5 - Screwdriver

1204517

<https://www.phoenixcontact.com/gb/products/1204517>



Actuation tool, for ST terminal blocks, also suitable for use as a bladed screwdriver, size: 0.6 x 3.5 x 100 mm, 2-component grip, with non-slip grip

# PLC-OSC- 24DC/ 24DC/ 2 - Solid-state relay module



2966634

<https://www.phoenixcontact.com/gb/products/2966634>

## PLC-V8/FLK14/OUT - System connection

2295554

<https://www.phoenixcontact.com/gb/products/2295554>



V8 adapter for 8 x PLC-INTERFACE (6.2 mm), controller: PLC system cabling of output cards, connection 1: Screw connection 1x, connection 2: IDC/FLK pin strip 1x 14-position, connection 3: Plug-in connection (Can be snapped onto 8x PLC-INTERFACE terminals), number of channels: 8, control logic: plusschaltend

---

## PLC-V8/FLK14/OUT/M - System connection

2304102

<https://www.phoenixcontact.com/gb/products/2304102>



V8 adapter for 8 x PLC-INTERFACE (6.2 mm), controller: PLC system cabling of output cards, connection 1: Screw connection 1x, connection 2: IDC/FLK pin strip 1x 14-position, connection 3: Plug-in connection (Can be snapped onto 8x PLC-INTERFACE terminals), number of channels: 8, control logic: minusschaltend

# PLC-OSC- 24DC/ 24DC/ 2 - Solid-state relay module



2966634

<https://www.phoenixcontact.com/gb/products/2966634>

## PLC-V8/D15S/OUT - System connection

2296058

<https://www.phoenixcontact.com/gb/products/2296058>



V8 adapter for 8 x PLC-INTERFACE (6.2 mm), controller: PLC system cabling of output cards, connection 1: Screw connection 1x, connection 2: D-SUB pin strip 1x 15-position, connection 3: Plug-in connection (Can be snapped onto 8x PLC-INTERFACE terminals), number of channels: 8, control logic: plusschaltend

---

## PLC-V8/D15B/OUT - System connection

2296061

<https://www.phoenixcontact.com/gb/products/2296061>



V8 adapter for 8 x PLC-INTERFACE (6.2 mm), controller: PLC system cabling of output cards, connection 1: Screw connection 1x, connection 2: D-SUB socket strip 1x 15-position, connection 3: Plug-in connection (Can be snapped onto 8x PLC-INTERFACE terminals), number of channels: 8, control logic: plusschaltend

# PLC-OSC- 24DC/ 24DC/ 2 - Solid-state relay module



2966634

<https://www.phoenixcontact.com/gb/products/2966634>

## PLC-FA-5X20 - Fuse adapter

1186510

<https://www.phoenixcontact.com/gb/products/1186510>



Safety plug adapter for use on a 6.2 mm PLC basic terminal block. For 5 x 20 mm fuses. Operating voltage: Universal. Without fuse failure indication.

---

## PLC-FA-I-5X20-12-24UC - Fuse adapter

1186499

<https://www.phoenixcontact.com/gb/products/1186499>



Safety plug adapter for use on a 6.2 mm PLC basic terminal block. For 5 x 20 mm fuses. Operating voltage: 12 ... 24 V AC/DC. With LED for fuse failure indication.

# PLC-OSC- 24DC/ 24DC/ 2 - Solid-state relay module



2966634

<https://www.phoenixcontact.com/gb/products/2966634>

## ZB 6:UNBEDRUCKT - Zack marker strip

1051003

<https://www.phoenixcontact.com/gb/products/1051003>



Zack marker strip, Strip, white, unlabeled, can be labeled with: PLOTMARK, CMS-P1-PLOTTER, mounting type: snapped, for terminal block width: 6.2 mm, lettering field size: 6.15 x 10.5 mm, Number of individual labels: 10

---

## ZB 6 CUS - Zack marker strip

0824992

<https://www.phoenixcontact.com/gb/products/0824992>



Zack marker strip, can be ordered: Strip, white, labeled according to customer specifications, mounting type: snap into tall marker groove, for terminal block width: 6.2 mm, lettering field size: 6.15 x 10.5 mm, Number of individual labels: 10



# PLC-OSC- 24DC/ 24DC/ 2 - Solid-state relay module



2966634

<https://www.phoenixcontact.com/gb/products/2966634>

## ZB 6,LGS:FORTL.ZAHLEN - Zack marker strip

1051016

<https://www.phoenixcontact.com/gb/products/1051016>



Zack marker strip, Strip, white, labeled, can be labeled with: CMS-P1-PLOTTER, printed horizontally: consecutive numbers 1 ... 10, 11 ... 20, etc. up to 491 ... 500, mounting type: snapped, for terminal block width: 6.2 mm, lettering field size: 6. 15 x 10.5 mm, Number of individual labels: 10

---

## ZB 6,QR:FORTL.ZAHLEN - Zack marker strip

1051029

<https://www.phoenixcontact.com/gb/products/1051029>

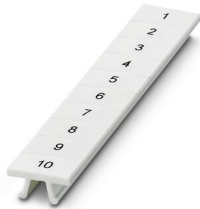

Zack marker strip, Strip, white, labeled, can be labeled with: CMS-P1-PLOTTER, Printed vertically: consecutive numbers 1 ... 10, 11 ... 20, etc. up to 491 ... 500, mounting type: snapped, for terminal block width: 6.2 mm, lettering field size: 6. 15 x 10.5 mm, Number of individual labels: 10

# PLC-OSC- 24DC/ 24DC/ 2 - Solid-state relay module



2966634

<https://www.phoenixcontact.com/gb/products/2966634>

## ZB 6,LGS:GLEICHE ZAHLEN - Zack marker strip

1051032

<https://www.phoenixcontact.com/gb/products/1051032>



Zack marker strip, Strip, white, labeled, can be labeled with: CMS-P1-PLOTTER, printed horizontally: Identical numbers 1 or 2, etc. up to 100, mounting type: snapped, for terminal block width: 6.2 mm, lettering field size: 6.15 x 10.5 mm, Number of individual labels: 10

---

## ZB 6,LGS:L1-N,PE - Marker for terminal blocks

1051414

<https://www.phoenixcontact.com/gb/products/1051414>



Marker for terminal blocks, Strip, white, labeled, can be labeled with: CMS-P1-PLOTTER, horizontal: L1, L2, L3, N, PE, L1, L2, L3, N, PE, mounting type: snapped, for terminal block width: 6.2 mm, lettering field size: 6.15 x 10.5 mm, Number of individual labels: 10

# PLC-OSC- 24DC/ 24DC/ 2 - Solid-state relay module



2966634

<https://www.phoenixcontact.com/gb/products/2966634>

## ZB 6,LGS:U-N - Marker for terminal blocks

1051430

<https://www.phoenixcontact.com/gb/products/1051430>



Marker for terminal blocks, Strip, white, labeled, can be labeled with: CMS-P1-PLOTTER, printed horizontally: U, V, W, N, GND, U, V, W, N, GND, mounting type: snapped, for terminal block width: 6.2 mm, lettering field size: 6.15 x 10.5 mm, Number of individual labels: 10

---

## UC-TM 6 - Marker for terminal blocks

0818085

<https://www.phoenixcontact.com/gb/products/0818085>



Marker for terminal blocks, Sheet, white, unlabeled, can be labeled with: BLUEMARK ID COLOR, BLUEMARK ID, BLUEMARK CLED, PLOTMARK, CMS-P1-PLOTTER, mounting type: snapped, for terminal block width: 6.2 mm, lettering field size: 5.6 x 10.5 mm, Number of individual labels: 80

# PLC-OSC- 24DC/ 24DC/ 2 - Solid-state relay module



2966634

<https://www.phoenixcontact.com/gb/products/2966634>

## UC-TM 6 CUS - Marker for terminal blocks

0824589

<https://www.phoenixcontact.com/gb/products/0824589>



Marker for terminal blocks, can be ordered: by sheet, white, labeled according to customer specifications, mounting type: snap into tall marker groove, for terminal block width: 6.2 mm, lettering field size: 5.6 x 10.5 mm, Number of individual labels: 80

---

## UCT-TM 6 - Marker for terminal blocks

0828736

<https://www.phoenixcontact.com/gb/products/0828736>



Marker for terminal blocks, Sheet, white, unlabeled, can be labeled with: TOPMARK NEO, TOPMARK LASER, BLUEMARK ID COLOR, BLUEMARK ID, BLUEMARK CLED, THERMOMARK PRIME, THERMOMARK CARD 2.0, THERMOMARK CARD, mounting type: snapped, for terminal block width: 6.2 mm, lettering field size: 5.6 x 10.5 mm, Number of individual labels: 60

# PLC-OSC- 24DC/ 24DC/ 2 - Solid-state relay module



2966634

<https://www.phoenixcontact.com/gb/products/2966634>

## UCT-TM 6 CUS - Marker for terminal blocks

0829602

<https://www.phoenixcontact.com/gb/products/0829602>



Marker for terminal blocks, can be ordered: by sheet, white, labeled according to customer specifications, mounting type: snap into tall marker groove, for terminal block width: 6.2 mm, lettering field size: 5.6 x 10.5 mm, Number of individual labels: 60

---

## NS 35/ 7,5 PERF 2000MM - DIN rail perforated

0801733

<https://www.phoenixcontact.com/gb/products/0801733>



DIN rail perforated, acc. to EN 60715, material: Steel, galvanized, passivated with a thick layer, Standard profile, color: silver, Pack of 25 (50 m)

# PLC-OSC- 24DC/ 24DC/ 2 - Solid-state relay module



2966634

<https://www.phoenixcontact.com/gb/products/2966634>

## NS 35/ 7,5 UNPERF 2000MM - DIN rail, unperforated

0801681

<https://www.phoenixcontact.com/gb/products/0801681>



DIN rail, unperforated, acc. to EN 60715, material: Steel, galvanized, passivated with a thick layer, Standard profile, color: silver, Pack of 25 (50 m)

---

## NS 35/ 7,5 WH PERF 2000MM - DIN rail perforated

1204119

<https://www.phoenixcontact.com/gb/products/1204119>



DIN rail perforated, acc. to EN 60715, material: Steel, Galvanized, white passivated, Standard profile, color: silver, Pack of 25 (50 m)

# PLC-OSC- 24DC/ 24DC/ 2 - Solid-state relay module



2966634

<https://www.phoenixcontact.com/gb/products/2966634>

## NS 35/ 7,5 WH UNPERF 2000MM-VPE 10 - DIN rail, unperforated

1204122

<https://www.phoenixcontact.com/gb/products/1204122>



DIN rail, unperforated, acc. to EN 60715, material: Steel, Galvanized, white passivated, Standard profile, color: silver, Pack of 10 (20 m)

---

## NS 35/ 7,5 AL UNPERF 2000MM - DIN rail, unperforated

0801704

<https://www.phoenixcontact.com/gb/products/0801704>



DIN rail, unperforated, acc. to EN 60715, material: Aluminum, uncoated, Standard profile, color: silver, Pack of 25 (50 m)

# PLC-OSC- 24DC/ 24DC/ 2 - Solid-state relay module



2966634

<https://www.phoenixcontact.com/gb/products/2966634>

## NS 35/ 7,5 ZN PERF 2000MM - DIN rail perforated

1206421

<https://www.phoenixcontact.com/gb/products/1206421>



DIN rail perforated, acc. to EN 60715, material: Steel, galvanized, Standard profile, color: silver, Pack of 25 (50 m)

---

## NS 35/ 7,5 ZN UNPERF 2000MM - DIN rail, unperforated

1206434

<https://www.phoenixcontact.com/gb/products/1206434>



DIN rail, unperforated, acc. to EN 60715, material: Steel, galvanized, Standard profile, color: silver, Pack of 25 (50 m)



# PLC-OSC- 24DC/ 24DC/ 2 - Solid-state relay module



2966634

<https://www.phoenixcontact.com/gb/products/2966634>

## NS 35/ 7,5 CU UNPERF 2000MM-VPE 10 - DIN rail, unperforated

0801762

<https://www.phoenixcontact.com/gb/products/0801762>



DIN rail, unperforated, acc. to EN 60715, material: Copper, uncoated, Standard profile, color: copper-colored, Pack of 10 (20 m)

---

## NS 35/ 7,5 CAP - End cap

1206560

<https://www.phoenixcontact.com/gb/products/1206560>

DIN rail end piece, for DIN rail NS 35/7.5



# PLC-OSC- 24DC/ 24DC/ 2 - Solid-state relay module



2966634

<https://www.phoenixcontact.com/gb/products/2966634>

## NS 35/15 PERF 2000MM - DIN rail perforated

1201730

<https://www.phoenixcontact.com/gb/products/1201730>



DIN rail perforated, similar to EN 60715, material: Steel, galvanized, passivated with a thick layer, Standard profile, color: silver, Pack of 25 (50 m)

---

## NS 35/15 UNPERF 2000MM - DIN rail, unperforated

1201714

<https://www.phoenixcontact.com/gb/products/1201714>



DIN rail, unperforated, similar to EN 60715, material: Steel, galvanized, passivated with a thick layer, Standard profile, color: silver, Pack of 25 (50 m)

# PLC-OSC- 24DC/ 24DC/ 2 - Solid-state relay module



2966634

<https://www.phoenixcontact.com/gb/products/2966634>

## NS 35/15 WH PERF 2000MM - DIN rail perforated

0806602

<https://www.phoenixcontact.com/gb/products/0806602>



DIN rail perforated, similar to EN 60715, material: Steel, Galvanized, white passivated, Standard profile, color: white, Pack of 25 (50 m)

---

## NS 35/15 WH UNPERF 2000MM-VPE 10 - DIN rail, unperforated

1204135

<https://www.phoenixcontact.com/gb/products/1204135>



DIN rail, unperforated, similar to EN 60715, material: Steel, Galvanized, white passivated, Standard profile, color: silver, Pack of 10 (20 m)

# PLC-OSC- 24DC/ 24DC/ 2 - Solid-state relay module



2966634

<https://www.phoenixcontact.com/gb/products/2966634>

## NS 35/15 AL UNPERF 2000MM - DIN rail, unperforated

1201756

<https://www.phoenixcontact.com/gb/products/1201756>



DIN rail, unperforated, similar to EN 60715, material: Aluminum, uncoated, Standard profile, color: silver

---

## NS 35/15 ZN PERF 2000MM - DIN rail perforated

1206599

<https://www.phoenixcontact.com/gb/products/1206599>



DIN rail perforated, similar to EN 60715, material: Steel, galvanized, Standard profile, color: silver, Pack of 25 (50 m)

# PLC-OSC- 24DC/ 24DC/ 2 - Solid-state relay module



2966634

<https://www.phoenixcontact.com/gb/products/2966634>

## NS 35/15 ZN UNPERF 2000MM - DIN rail, unperforated

1206586

<https://www.phoenixcontact.com/gb/products/1206586>



DIN rail, unperforated, similar to EN 60715, material: Steel, galvanized, Standard profile, color: silver, Pack of 25 (50 m)

---

## NS 35/15 CU UNPERF 2000MM-VPE 10 - DIN rail, unperforated

1201895

<https://www.phoenixcontact.com/gb/products/1201895>



DIN rail, unperforated, similar to EN 60715, material: Copper, uncoated, Standard profile, color: copper-colored, Pack of 10 (20 m)

# PLC-OSC- 24DC/ 24DC/ 2 - Solid-state relay module



2966634

<https://www.phoenixcontact.com/gb/products/2966634>

## NS 35/15 CAP - End cap

1206573

<https://www.phoenixcontact.com/gb/products/1206573>

DIN rail end piece, for DIN rail NS 35/15

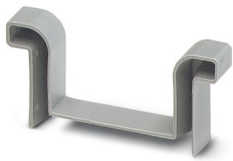

---

## NS 35/15-2,3 UNPERF 2000MM-VPE 10 - DIN rail, unperforated

1201798

<https://www.phoenixcontact.com/gb/products/1201798>

DIN rail, unperforated, acc. to EN 60715, material: Steel, galvanized, passivated with a thick layer, Standard profile 2.3 mm, color: silver, Pack of 10 (20 m)



# PLC-OSC- 24DC/ 24DC/ 2 - Solid-state relay module



2966634

<https://www.phoenixcontact.com/gb/products/2966634>

## PLC-BSC- 24DC/21 - Relay base

2966016

<https://www.phoenixcontact.com/gb/products/2966016>



6.2 mm PLC basic terminal block with screw connection, without relay or solid-state relay, for mounting on DIN rail NS 35/7,5, 1 changeover contact, input voltage 24 V DC

## OPT-24DC/ 24DC/ 2 - Miniature solid-state relay

2966595

<https://www.phoenixcontact.com/gb/products/2966595>

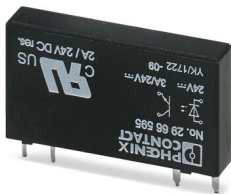

Plug-in miniature solid-state relay, power solid-state relay, 1 N/O contact, input: 24 V DC, output: 3 ... 33 V DC/3 A

Phoenix Contact 2023 © - all rights reserved  
<https://www.phoenixcontact.com>

PHOENIX CONTACT Ltd  
Halesfield 13, Telford  
Shropshire, TF7 4PG  
01952 681700  
[info@phoenixcontact.co.uk](mailto:info@phoenixcontact.co.uk)